



INSTALLATION INSTRUCTIONS

50 Ohm EIA CONNECTORS

Kabelwerk | **EUPEN** AG

M36387 - M36388 - M36389
Rev.00/2017-03-03

cable

1/2

EIA connectors for cables 7/8" to 1-5/8"



EIA78V78N



EIA78V114N



EIA78V158N



EIA158V158N

Coupling hardware
(sold separately):



EIA78CH
(for interface EIA 7/8")



EIA158CH
(for interface EIA 1-5/8")

7/8"	EC5-50-A (5228 A)
1-1/4"	EC6-50-A (5328 A)
1-5/8"	EC7-50-A (5438 A)



Vaseline



Mastic tape*

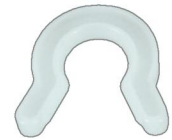

Saw-guide

* A Butyl mastic tape is available in our Weatherproofing Tape Kit (ref. 2849996)

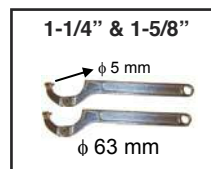
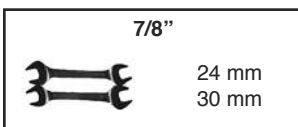

Manual method

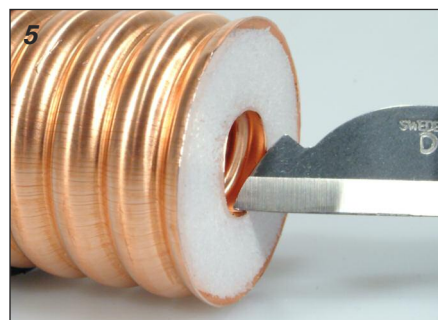
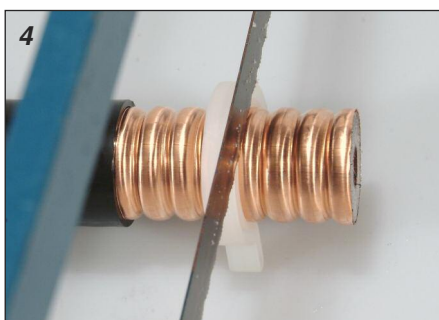
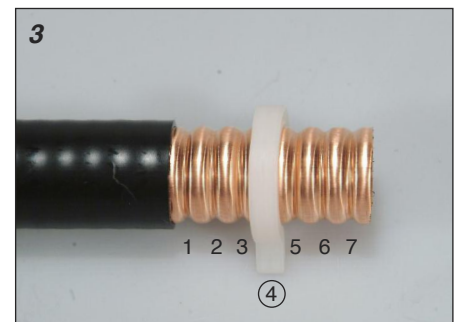
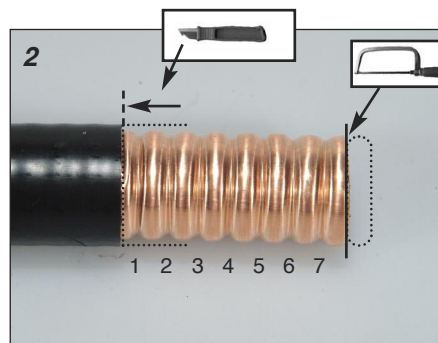
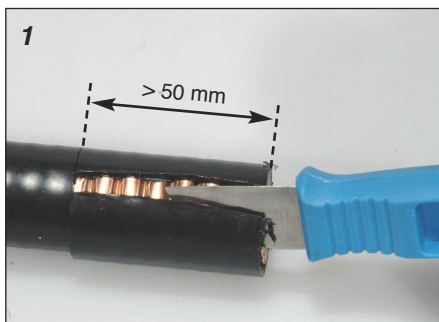



INSTALLATION INSTRUCTIONS

50 Ohm EIA CONNECTORS

Kabelwerk | **EUPEN** AG

M36387 - M36388 - M36389
Rev.00/2017-03-03

cable

2/2

EIA connectors for cables 7/8" to 1-5/8"

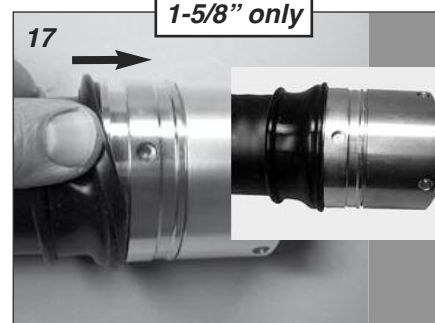
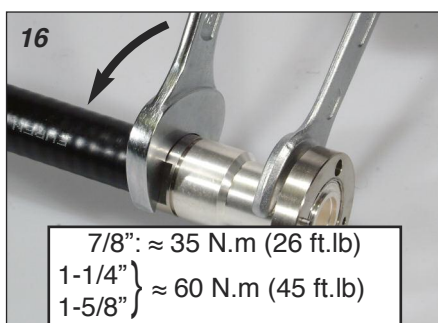
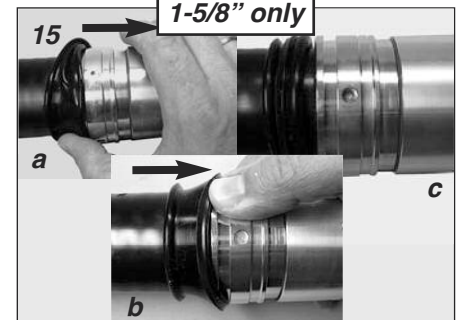
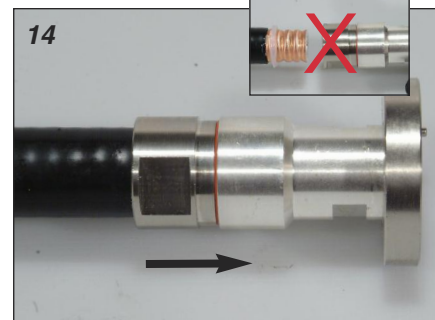
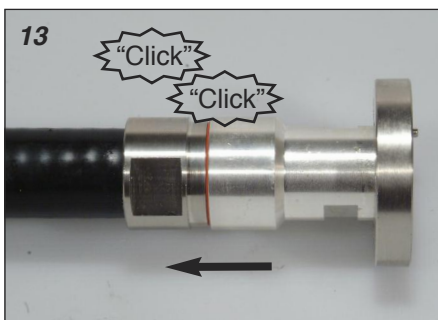
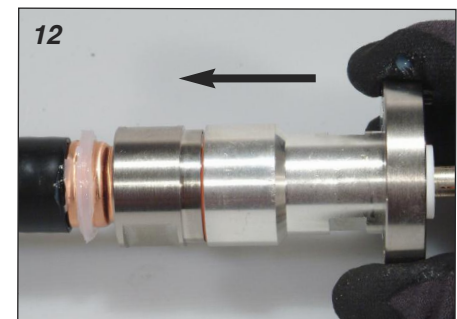
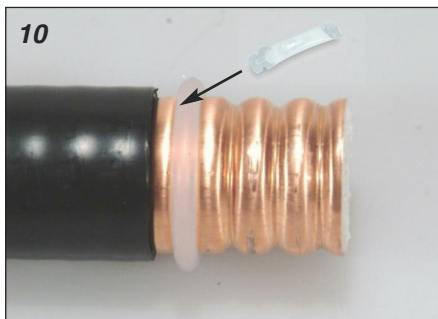
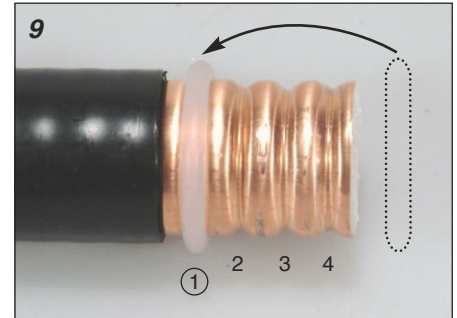
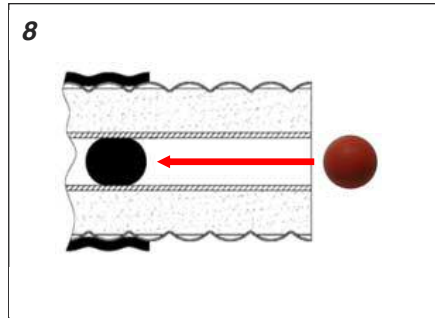
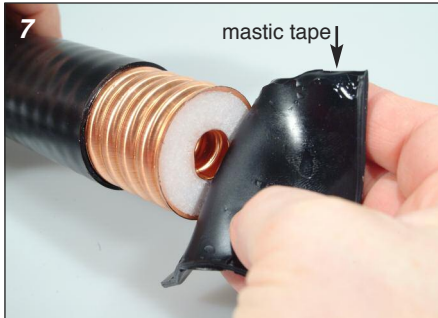

For any questions please contact KABELWERK EUPEN AG / for US Customer service call 1-800-419-5100

(D) Verarbeitung nur durch eine Elektrofachkraft.
Es besteht die Gefahr eines elektrischen Schlagess!

(F) Installation uniquement par une personne qualifiée en électricité.
Il y a un risque de choc électrique!



(NL) Installatie alleen door een vakman voor elektriciteit.
Er is gevaar van elektrische schok!

(GB) Processing only by a qualified electrician.
There is a risk of electric shock!

NOTI E:
KABELWERK EUPEN AG
disclaims any liability or
responsibility for the results
of improper or unsafe installa-
tion practices.

AVIS:
KABELWERK EUPEN AG
décline toute responsabilité
en cas de non respect de
ces instructions.

WAARS HUWING:
KABELWERK EUPEN AG
wijst elke verantwoordelijk-
heid van de hand in geval
van het niet opvolgen van
deze aanbevelingen.

BEMERKUNG:
KABELWERK EUPEN AG
lehnt jede Verantwortung bei
Nichtbeachtung dieser
Instruktionen ab.

AVISO:
KABELWERK EUPEN AG
rehusa todas las responsibi-
lidades en caso de no
respetar las instrucciones.

注意:
本公司声明对于不恰当或不
安全的安装, 检验, 维修或拆
卸操作所导致的后果不负任
何义务和责任